

Preparation

**Part Number: 08586-48090**

**NOTE:** Part number of this accessory may not be the same as the part number shown.

**Kit Contents**

Item #	Quantity Reqd.	Description
1	1	Wire Harness
2	1	GBS ECU
3	1	Security ECU Mounting Bracket
4	1	GBS ECU Mounting Bracket
5	1	Status Monitor
6	1	Security ECU

Special Chemicals	Notes
Cleaner	3M™ Prep Solvent-70
Glass Cleaner	Household Windex

**General Applicability**

Note: Highlander Hybrid with factory keyless entry system only.

**Hardware Bag Contents**

Item #	Quantity Reqd.	Description
1	1	Microphone
2	5	Small Foam Tape Strip
3	15	Medium Wire Ties
4	5	Large Wire Ties
5	1	Bolt
6	1	Key Tag
7	2	Warning Labels
8	1	Owner's Manual
9	1	Warranty Card

**Recommended Sequence of Application**

Item #	Accessory

\*Mandatory

**Vehicle Service Parts** (may be required for reassembly)

Item #	Quantity Reqd.	Description

**Additional Items Required For Installation**

Item #	Quantity Reqd.	Description

**Conflicts**

Note: Must not be installed in vehicles with factory TDS.

**Recommended Tools**

Personal & Vehicle Protection	Notes
Safety Glasses	
Safety Gloves	(Optional)
Vehicle Protection	Blankets, Part Boxes
Special Tools	Notes
Striker Tool (PPO only)	CAD-E IADS P/N: ALL 06-016-01
Installation Tools	Notes
Phillips Head Screwdriver	#2, screwdriver or tip
Flat Blade Screwdriver	Small
Socket	10 mm, 12 mm
Nylon Panel Removal Tool	e.g. Panel Pry Tool #1 Toyota SST # 00002-06001-01
Pneumatic/Electric Wrench	
Wrench	10 mm
Torque Wrench	6.35N·m (56 lbf·in)
Side Cutters	
Masking Tape	

**Legend**

 **STOP:** Damage to the vehicle may occur. Do not proceed until process has been complied with.

 **OPERATOR SAFETY:** Use caution to avoid risk of injury.

 **CAUTION:** A process that must be carefully observed in order to reduce the risk of damage to the accessory/vehicle and to ensure a quality installation.

 **TOOLS & EQUIPMENT:** Used in Figures calls out the specific tools and equipment recommended for this process.

 **REVISION MARK:** This mark highlights a change in installation with respect to previous issue.

**Procedure**

Care must be taken when installing this accessory to ensure damage does not occur to the vehicle. The installation of this accessory should follow approved guidelines to ensure a quality installation.

These guidelines can be found in the "Accessory Installation Practices" document.

This document covers such items as:-

- Vehicle Protection (use of covers and blankets, cleaning chemicals, etc.).
- Safety (eye protection, rechecking torque procedure, etc.).
- Vehicle Disassembly/Reassembly (panel removal, part storage, etc.).
- Electrical Component Disassembly/Reassembly (battery disconnection, connector removal, etc.).

Please see your Toyota dealer for a copy of this document.

**1. Vehicle Disassembly.**

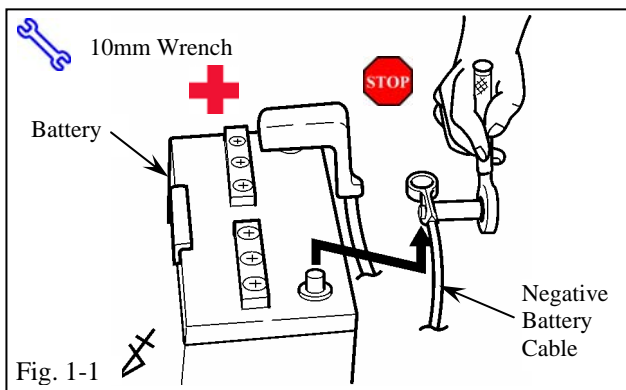

(a) Remove the negative battery cable. (Fig. 1-1)

- (1) Protect the fender before starting.
- (2) Do not touch the positive terminal with any tool removing the cable.

(b) Remove the air damper wire terminal from the bottom of the glove box. (Fig. 1-2)

- (1) Remove the clip securing the air damper wire terminal.

(c) Remove the glove box. (Fig. 1-3)

- (1) Remove two stoppers securing the bottom of the glove box.

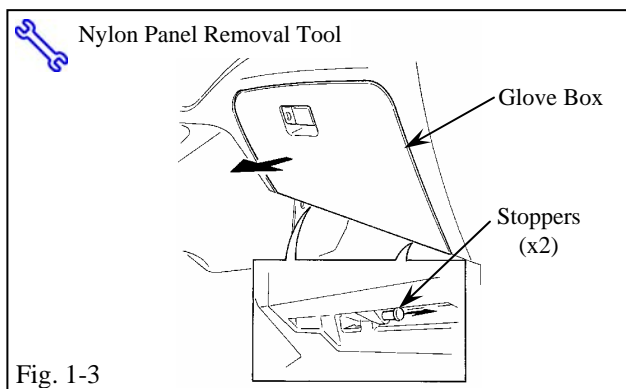
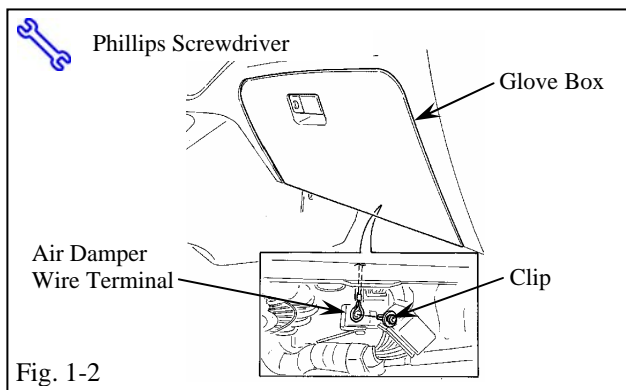

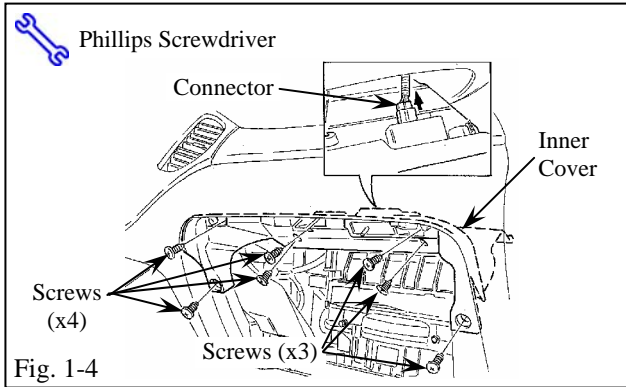

(d) Remove the glove box inner cover (Fig. 1-4)

(1) Remove seven screws securing the cover.

(2) Disconnect one connector.

(e) Remove the passenger side panel. (Fig. 1-5)

(1) Remove two clips securing the cover.

(f) Remove the driver's step cover. (Fig. 1-6)



(1) Attach the masking tape to the dashboard as shown.



(2) Cover the floor and seats before starting.

(g) Remove the driver's cowl cover. (Fig. 1-7)

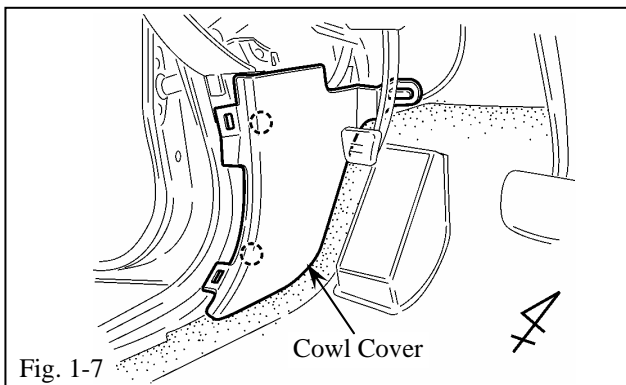
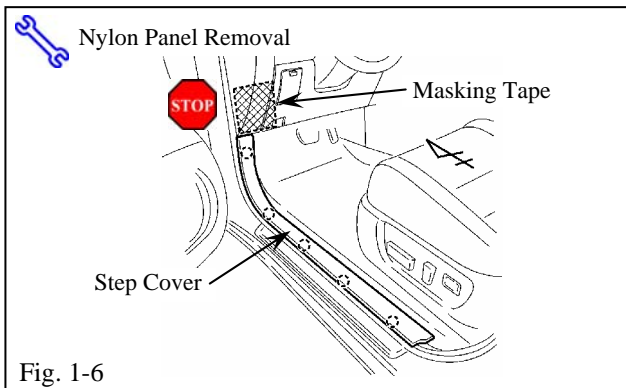
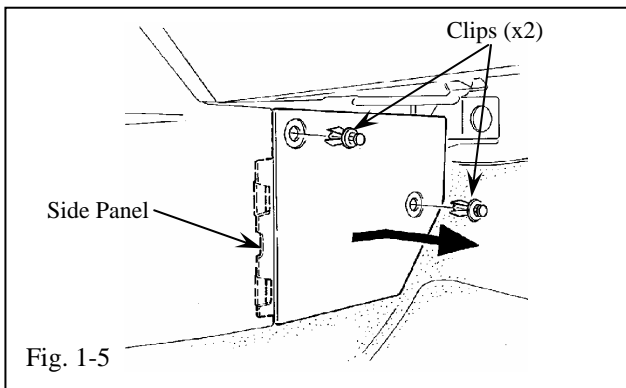

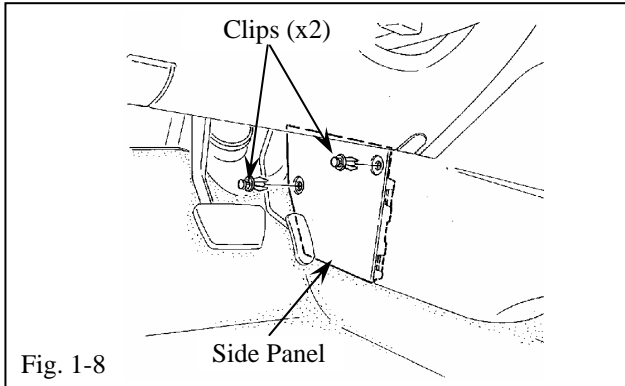

Fig. 1-8

(h) Remove the driver side panel. (Fig. 1-8)

(1) Remove two clips securing the cover.

(i) Open the bolt cover of the lower dash cover. Use screwdriver (small tip) to insert in bottom hole of cover to loosen cover. (Fig. 1-9)

(j) Remove the hood release latch. (Fig. 1-9)

(1) Do not bend the hood release cable.

(k) Remove the lower dash cover. (Fig. 1-10)

(1) Remove two bolts securing the lower dash cover.

(2) If equipped with automatic temperature control, the cabin temperature sensor connector and white aspirator tube must be disconnected from the lower dash.

(3) Remove the diagnostic connector from the lower dash cover.

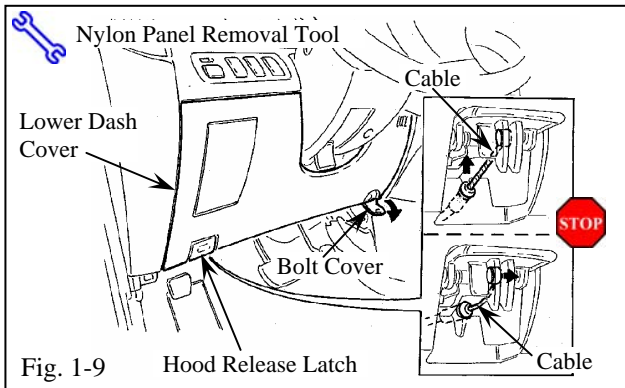

Fig. 1-9

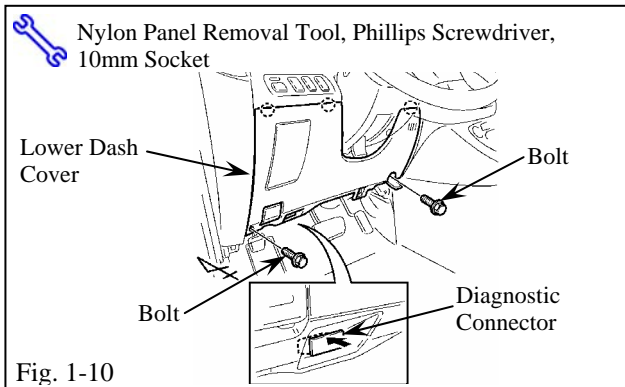

Fig. 1-10

(l) Remove the metal substructure. (Fig. 1-11)

(1) Remove three bolts securing the metal substructure.



(2) Be careful not to get cut by the sharp metal edges.

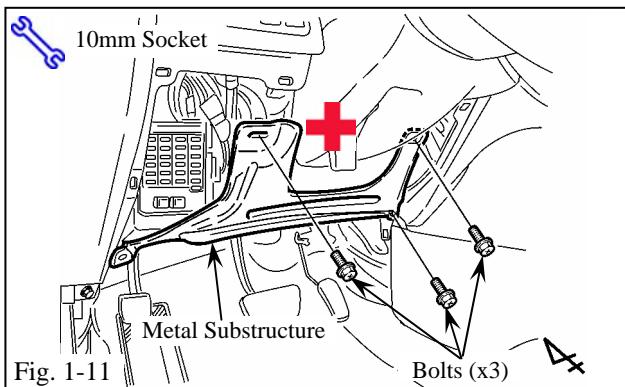
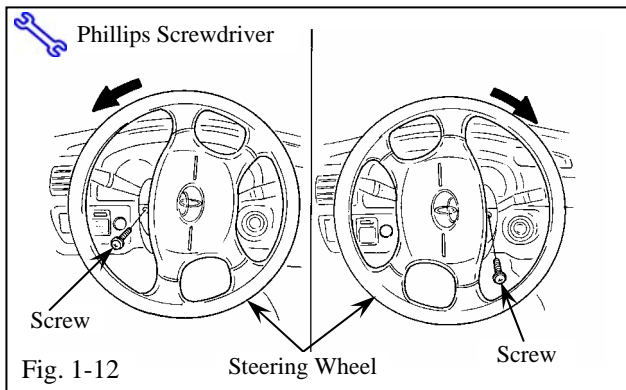

Fig. 1-11



(m) Remove two screws, located behind the steering wheel, securing the bottom steering column cover. (Fig. 1-12)

(1) Insert the key into the ignition switch and turn it to ON, then turn the steering wheel left or right to gain access to the screws.

(n) Remove the lower steering column cover. (Fig. 1-13)

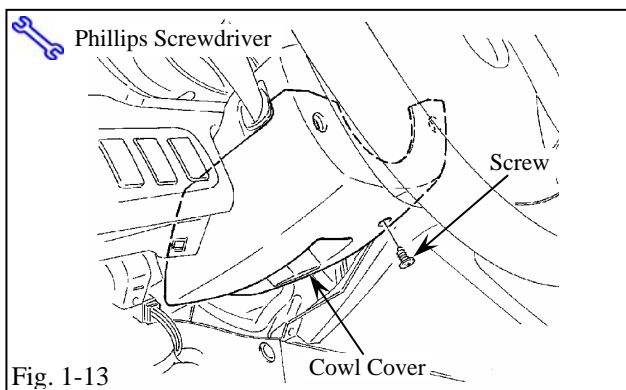

(1) Remove the bottom screw securing the cover.

**2. V5 Harness Installation.**

(a) Locate and disconnect the gray 7P connector and white 14P connector from the driver side cowl area. (Fig. 2-1)

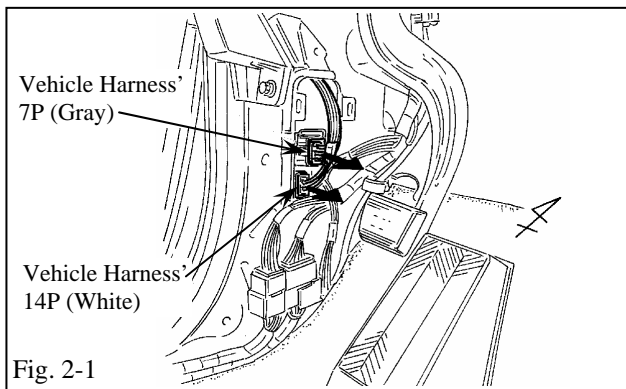

(b) Plug in the V5 harness' gray 7P connectors between the vehicle harness' gray 7P connector and the driver side connector block. (Fig. 2-2)

(1) Verify the connectors are plugged in securely.

(c) Plug in the V5 harness' white 14P connectors between the vehicle harness' white 14P connector and the driver side connector block. (Fig. 2-2)

(1) Verify the connectors are plugged in securely.

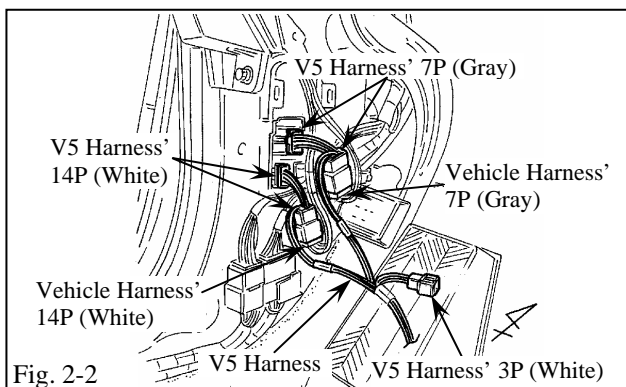

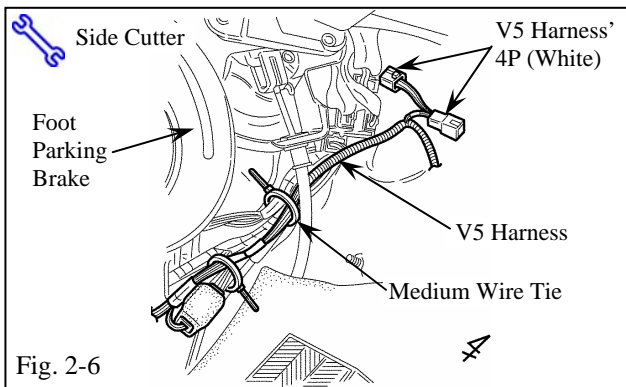
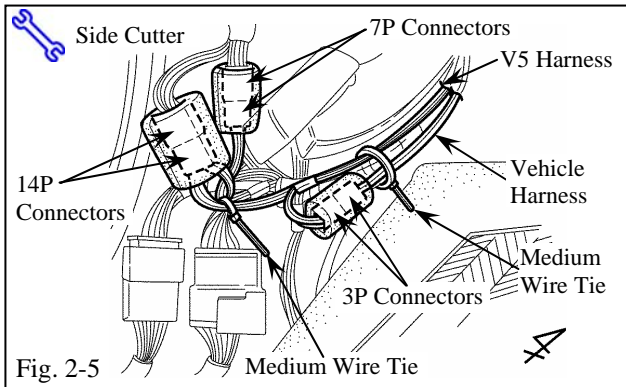
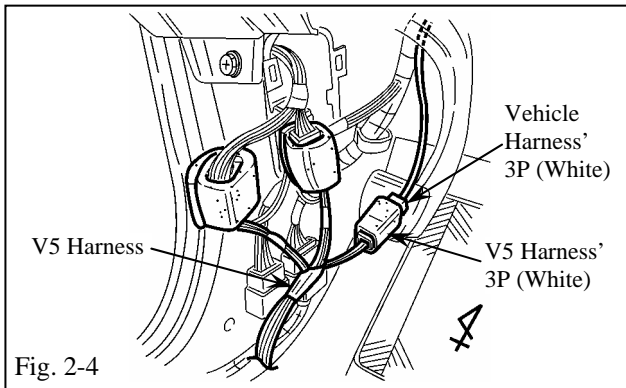
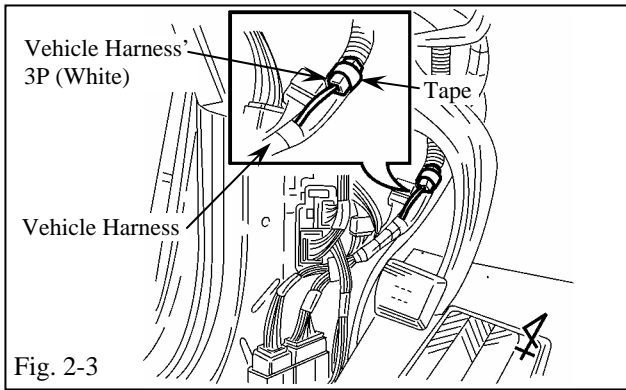

- (d) Locate and remove the tape securing the vehicle harness' white 3P connector from the driver side cowl area. (Fig. 2-3)
- (e) Plug in the V5 harness' white 3P connector into the vehicle's white 3P connector. (Fig. 2-4)
  - (1) Verify the connectors are plugged in securely.
- (f) Secure the V5 harness' 14P connector and 7P connector to the vehicle harness with one medium wire tie. (Fig. 2-5)
- (g) Secure the V5 harness and the vehicle's 3P connector harness to the vehicle harness with one medium wire tie. (Fig. 2-5)
- (h) Route the V5 harness up toward the Instrument Panel J/B, then secure it to the vehicle harness with one medium wire tie. (Fig. 2-6)

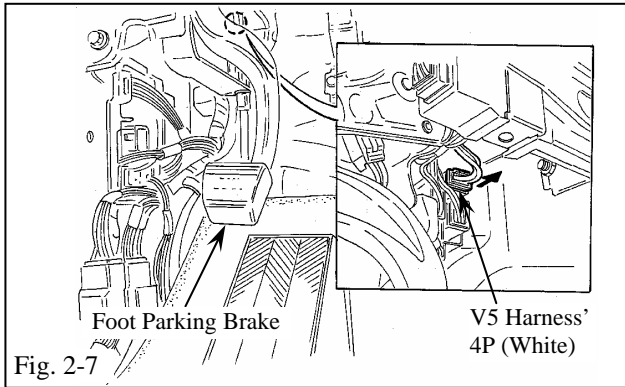

- (i) Locate and disconnect the white 4P connector from the driver side cowl area. (Fig. 2-7)
- (j) Plug in the V5 harness' white 4P connector into the vehicle harness' white 4P connector. (Fig. 2-8)
- (l) Verify the connectors are plugged in securely.

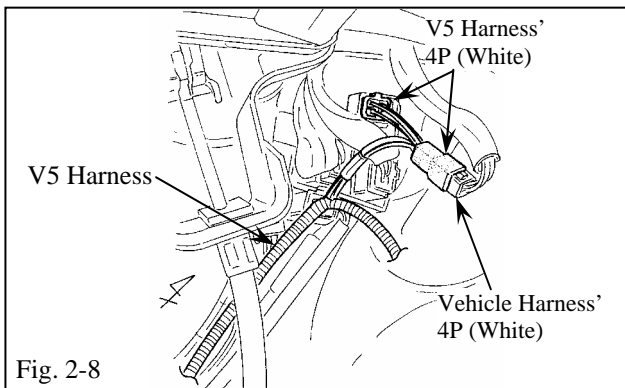

- (k) Looking up from the back of the Instrument Panel J/B, route the V5 harness toward the Instrument Panel J/B, then secure it to the vehicle harness with three large wire ties. (Fig. 2-9)

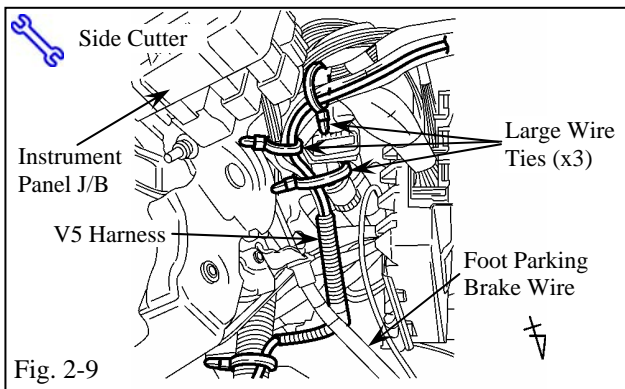

- (l) Route the V5 harness toward the steering column area, then secure it to the vehicle harness with one large wire tie. (Fig. 2-10)

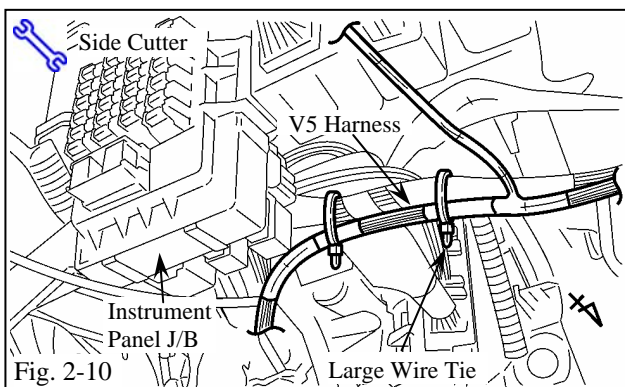

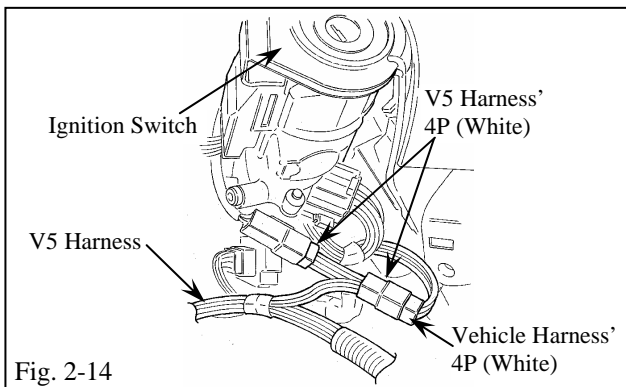
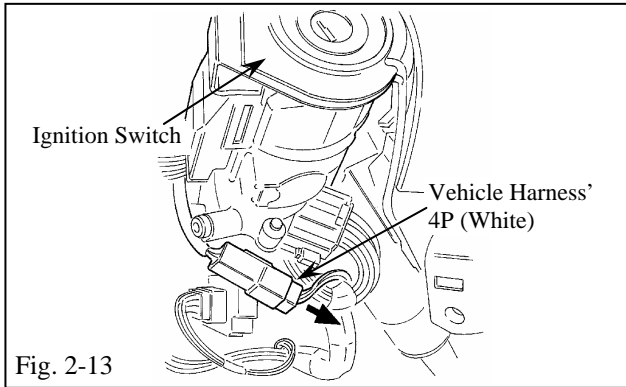
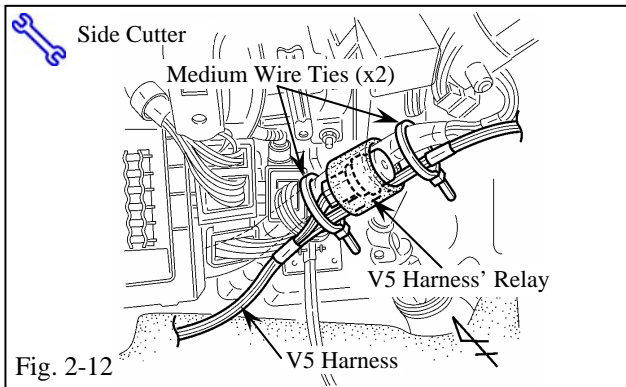
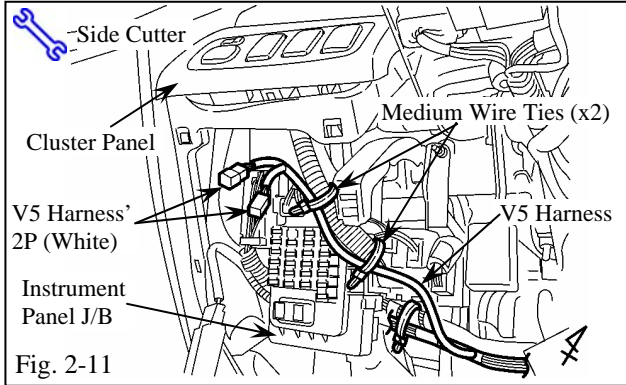

- (m) Route the V5 harness up toward the cluster panel area, then secure it to the vehicle harness with two medium wire ties. (Fig. 2-11)
- (n) Secure the V5 harness to the vehicle harness with two medium wire ties. (Fig. 2-12)
- (o) Locate and disconnect the white 4P connector from the ignition switch. (Fig. 2-13)
- (p) Plug in the V5 harness' white 4P connectors between the vehicle harness' white 4P connector and the ignition switch. (Fig. 2-14)
- (1) Verify the connectors are plugged in securely.

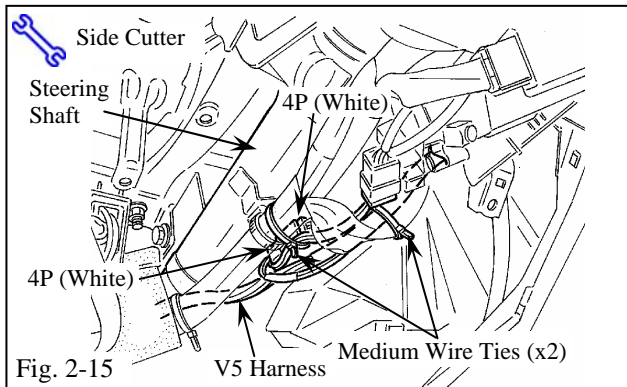

(q) Secure the white 4P connectors to the vehicle harness with one medium wire tie. (Fig. 2-15)

(r) Secure the V5 harness to the vehicle harness with one medium wire tie. (Fig. 2-15)

(s) Route the V5 harness toward the center console area, then secure it to the brace with one medium wire tie. (Fig. 2-16)

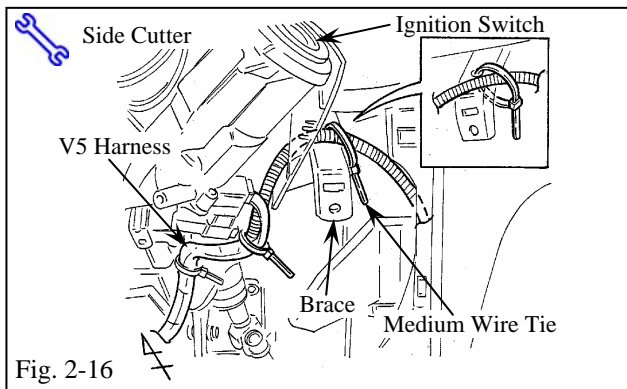

(1) Insert a medium wire tie through the hole in the driver side brace, then secure the V5 harness with the medium wire tie.

(t) Route the V5 harness toward the center console area, then secure it to the driver side brace with one medium wire tie. (Fig. 2-17)

(1) Insert a medium wire tie through the hole in the brace, then secure the V5 harness with the medium wire tie.

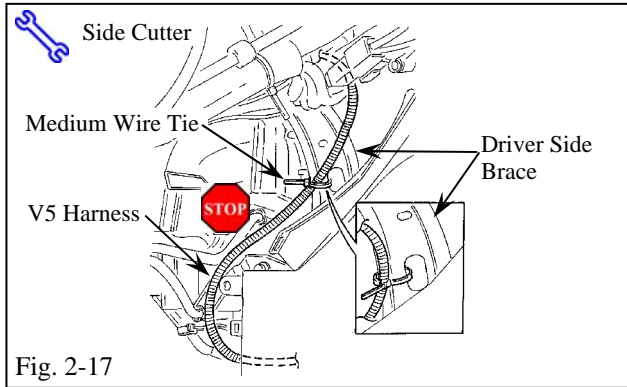

(2) Route the V5 harness away from any moving parts such as levers, etc.

(u) Route the V5 harness behind the center console, through the opening between the heater unit and floor. (Fig. 2-18)

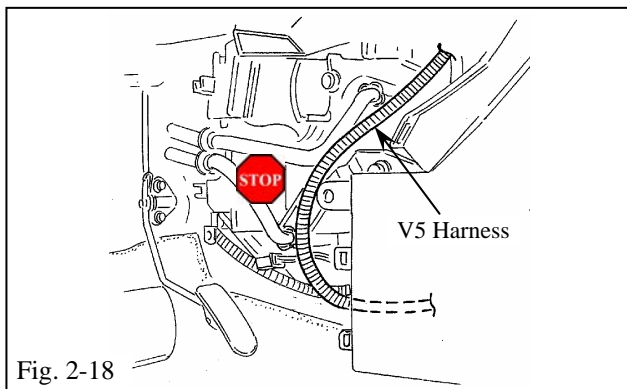

(1) Route the V5 harness away from any moving parts such as levers, etc.

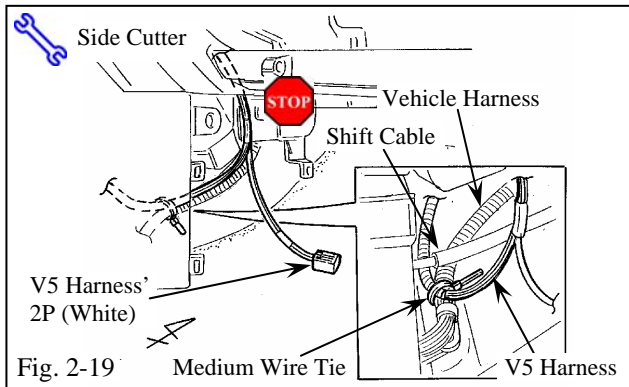

Fig. 2-19

(v) Draw out the V5 harness from the passenger side center console area, then secure it to the vehicle harness with one medium wire tie. (Fig. 2-19)

(1) Route the V5 harness below the shift cable, then secure the V5 harness to the vehicle harness near the vehicle's clip.

(2) Route the V5 harness away from any moving parts such as levers, etc.

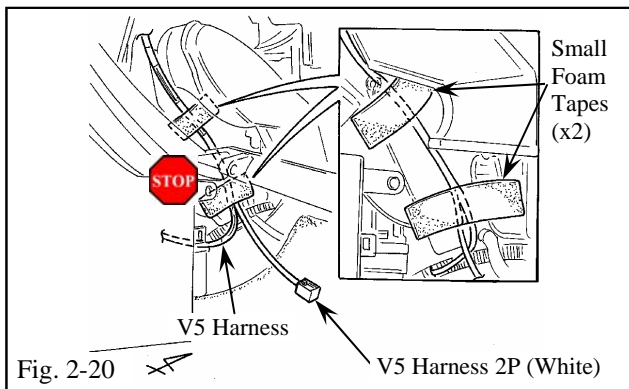

Fig. 2-20

(w) Route the V5 harness up toward the instrument panel, then secure it to the passenger side heater unit with two small strips of foam tape. (Fig. 2-20)

(1) Route the V5 harness away from any moving parts such as levers, etc.

(x) Route the V5 harness up toward the instrument panel. (Fig. 2-21)

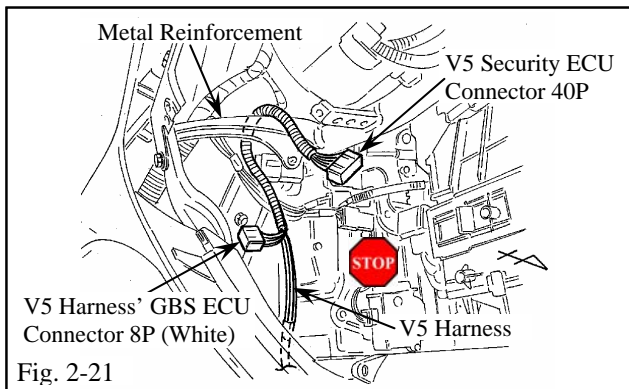

Fig. 2-21

(1) Route the V5 harness' white 40P connector around the back of the metal reinforcement.

(2) Route the V5 harness away from any moving parts such as levers, etc.

**3. V5 ECU Preparation and Installation.**

(a) Turn the GBS adjustment screw on the GBS ECU to the "9" position. (Fig. 3-1)

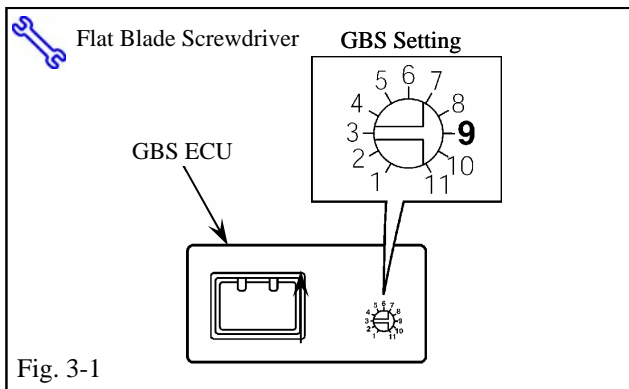

Fig. 3-1

Procedure

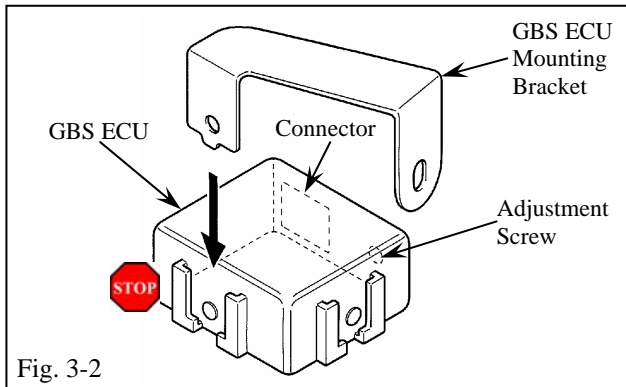

Fig. 3-2

(b) Insert the GBS ECU mounting bracket into the indicated bracket slot on the GBS ECU. (Fig. 3-2)



(1) Insert the mounting bracket into the correct slot; you have only one chance to install it properly.

(c) Plug in the V5 harness' white 8P connector to the GBS ECU. (Fig. 3-3)

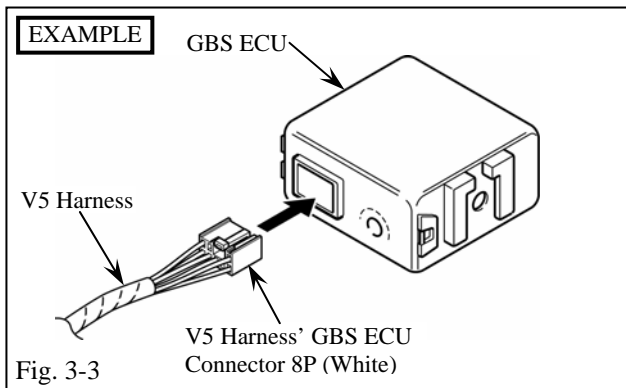

Fig. 3-3

(1) Verify the connectors are plugged in securely.

(d) Locate and remove the vehicle's existing nut from the passenger side center brace. (Fig. 3-4)



(1) Do not discard the nut.

(e) Using the stud bolt and existing nut, secure the GBS ECU to the passenger side center brace in the center console area. (Fig. 3-5)

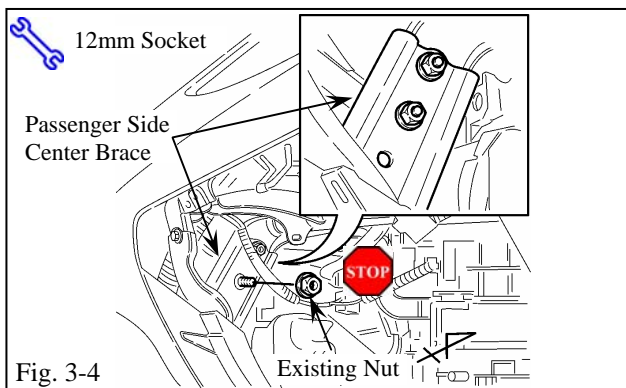

Fig. 3-4

(1) Secure the GBS ECU as shown.

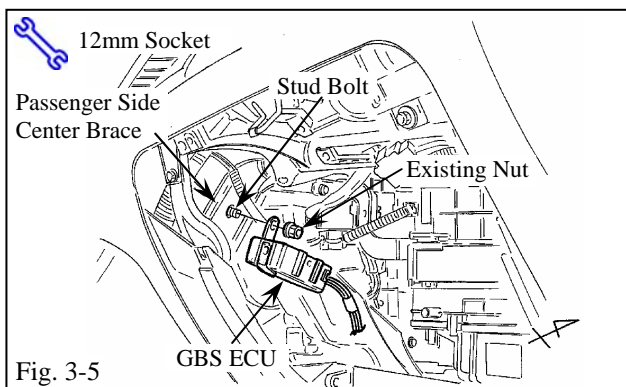
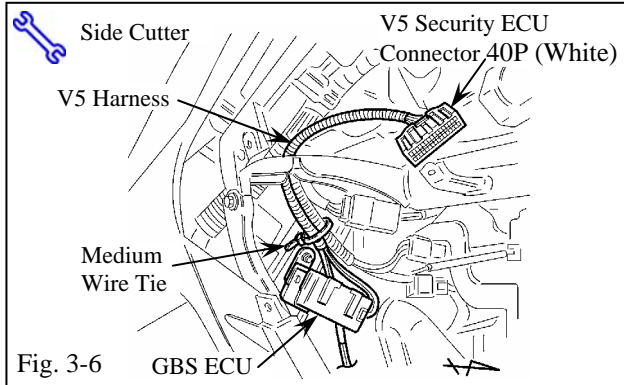

Fig. 3-5



- (f) Secure the V5 harness to the vehicle harness with one medium wire tie. (Fig. 3-6)
- (g) Insert the V5 security ECU mounting bracket into the indicated bracket slot on the V5 security ECU. (Fig. 3-7)



- (1) Insert the mounting bracket into the correct slot; you have only one chance to install it properly.



- (h) Plug in the V5 harness' white 40P connector to the V5 security ECU. (Fig. 3-8)

- (1) Verify the connectors are plugged in securely.

- (i) Looking up from the glove box, locate the weld nut near the edge of the instrument panel. (Fig. 3-9)

- (1) Weld nut is located to the left of latch.

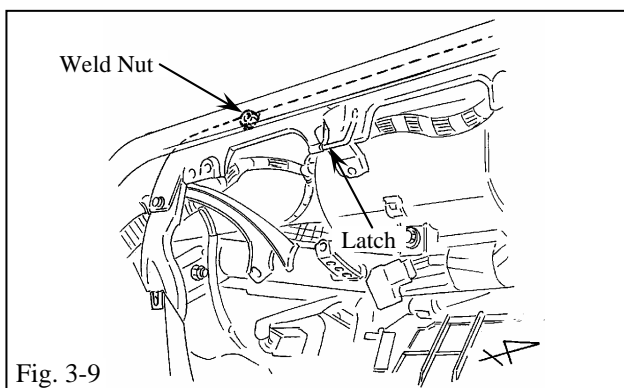
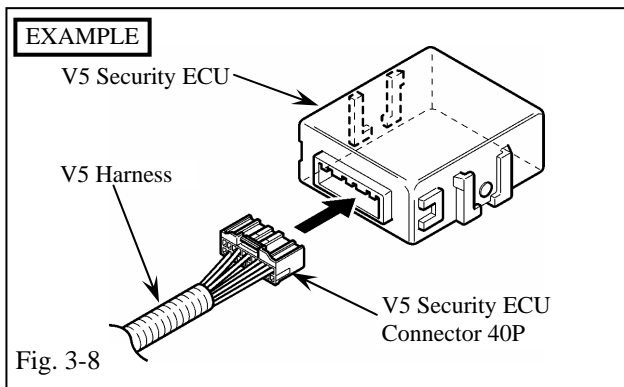
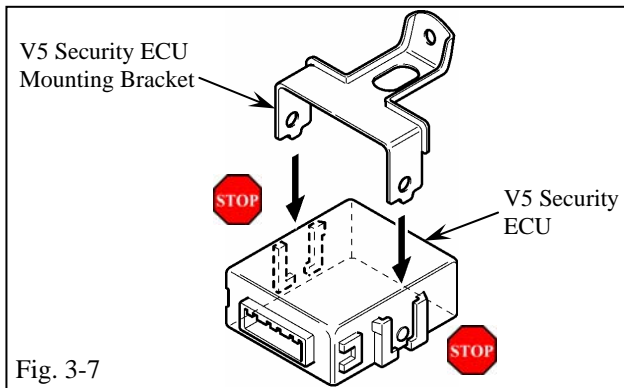

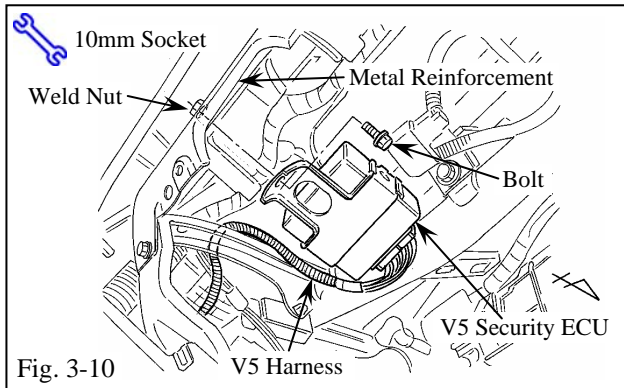

- (j) Using the supplied bolt, secure the V5 security ECU to the metal reinforcement. (Fig. 3-10)

(1) Secure the V5 security ECU as shown.

**4. Microphone Installation.**

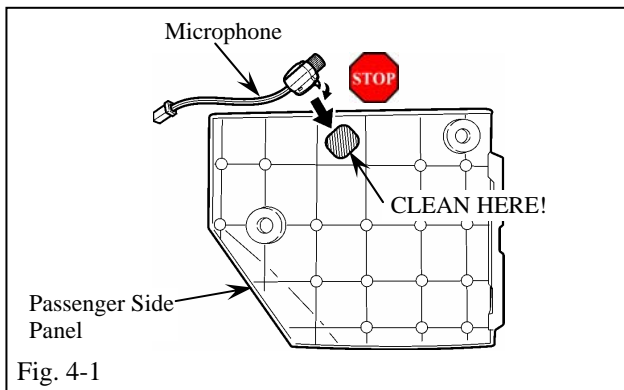

- (a) Using the 3M™ Prep Solvent-70, clean the area indicated on the backside of the passenger side panel. (Fig. 4-1)

(1) When cleaning with 3M™ Prep Solvent-70, follow the manufacturer's directions. Do not allow cleaner to air dry.

- (b) Remove the backing sheet and secure the microphone to the backside of the passenger side panel. (Fig. 4-1)

(1) Secure the microphone as shown.

(2) Do not touch the adhesive surface of the microphone.

(3) Press the microphone to the passenger side panel firmly.

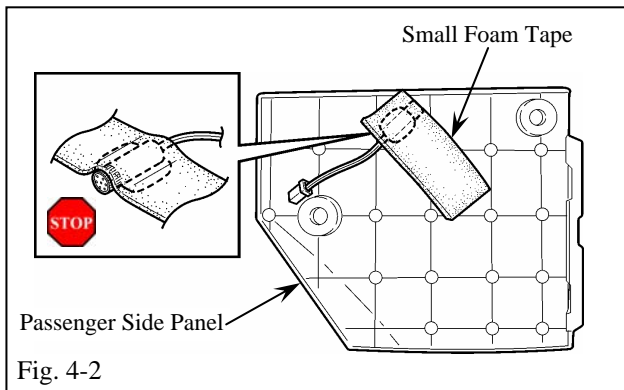

- (c) Secure the microphone with one small strip of foam tape. (Fig. 4-2)

(1) Do not cover the opening of the microphone with the foam tape.

- (d) Plug in the V5 harness' white 2P connector to the microphone's white 2P connector. (Fig. 4-3)

(1) Verify the connectors are plugged in securely.

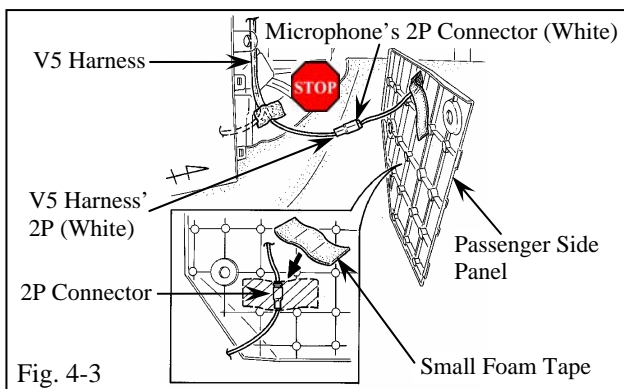

- (e) Secure the 2P connectors to the passenger side panel with a small foam strip of foam tape. (Fig. 4-3)

- (f) Reinstall the passenger side panel. Ensure that the V5 harness does not interfere with moving parts.

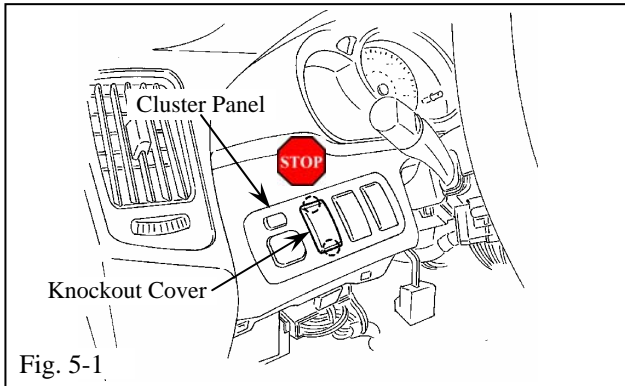

Fig. 5-1

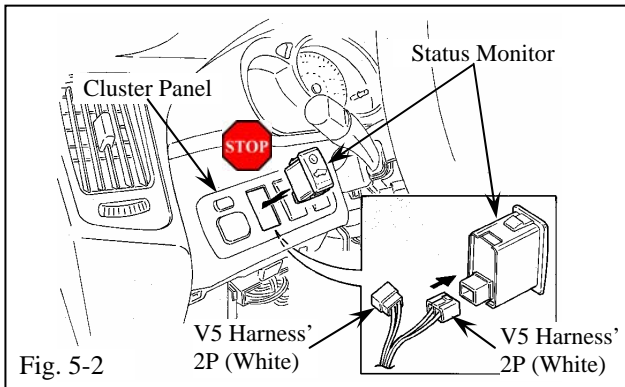

Fig. 5-2

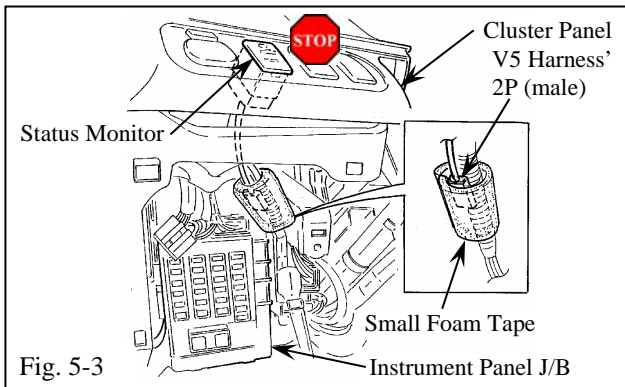

Fig. 5-3

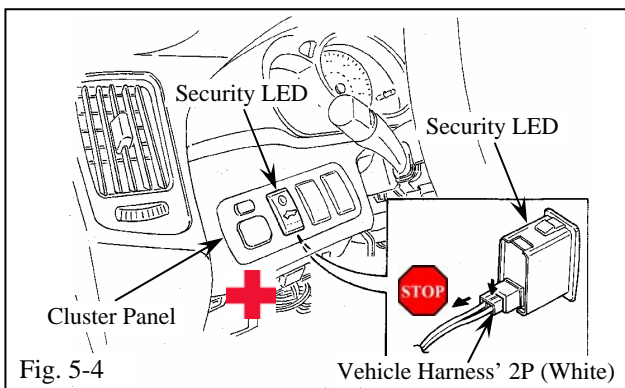

Fig. 5-4

**5. Status Monitor Installation.**

**FOR VEHICLES WITHOUT IMMOBILIZER SYSTEM ONLY. (Steps 5.(a) – 5.(d))**

- (a) Remove the knockout cover from the far left space of the cluster panel. (Fig. 5-1)
  - (1) Do not perform this step if the vehicle has an immobilizer system.
- (b) Plug in the V5 harness' white 2P connector to the status monitor. (Fig. 5-2)
  - (1) Do not perform this step if the vehicle has an immobilizer system.
  - (2) Verify the connectors are plugged in securely.
- (c) Insert the status monitor into the knockout opening of the cluster panel. (Fig. 5-2)
  - (1) Do not use the V5 Harness' white 2P connector (male).
- (d) Do not use the V5 harness' white 2P connector (male); wrap it to the vehicle harness with one small strip of foam tape. (Fig. 5-3)
  - (1) Do not perform this step if the vehicle has an immobilizer system.

**FOR VEHICLES WITH IMMOBILIZER SYSTEM ONLY. (Steps 5.(e) – 5.(f))**

- (e) Locate the security LED in the cluster panel. (Fig. 5-4)
  - (1) Do not perform this step if the vehicle does not have an immobilizer system.
- (f) Disconnect the vehicle harness from the security LED's white 2P connector.
  - (1) Do not remove the security LED.
  - (2) Be careful not to get cut by the sharp metal edge.

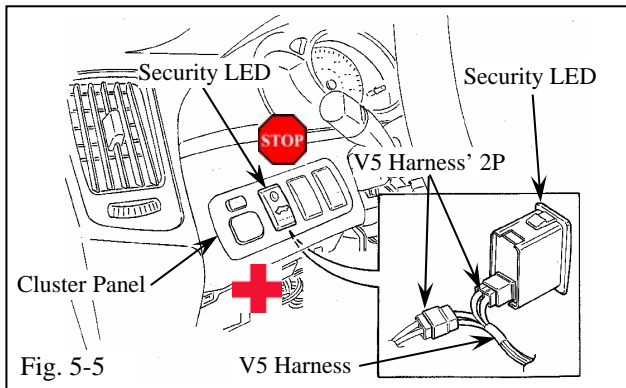

FOR VEHICLES WITH IMMOBILIZER SYSTEM ONLY. (Steps 5.(g) – 5.(h))

(g) Plug in the V5 harness' white 2P connectors between the vehicle harness' white 2P connector and the security LED. (Fig. 5-5)

- (1) Do not perform this step if the vehicle does not have an immobilizer system.
- (2) Verify the connectors are plugged in securely.

(3) Be careful not to get cut by the sharp metal edge.

(h) Secure the white 2P connectors to the vehicle harness with one small strip of foam tape. (Fig. 5-6)

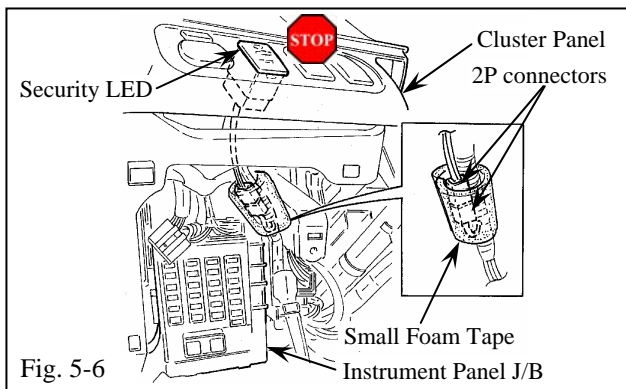

- (1) Do not perform this step if the vehicle does not have an immobilizer system.

**6. Warning Label and Key Tag Installation.**

(a) Clean the inside surface of the front door's windows. (Fig. 6-1)

(b) Place the warning label on the inside surface of the front door's windows as shown. (Fig. 6-1)

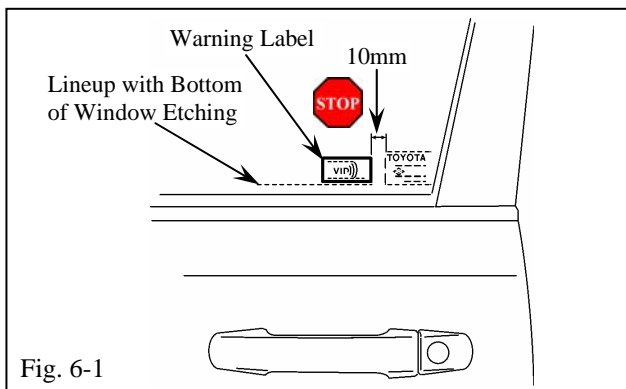

(1) Use a piece of clean adhesive tape to lift the labels off their protective backing sheet.

(2) Do not touch the adhesive surface of the warning labels.

(c) Hang the key tag to the remote control key's ring. (Fig. 6-2)

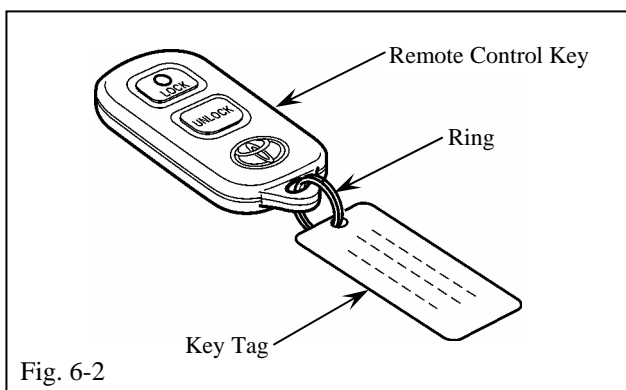

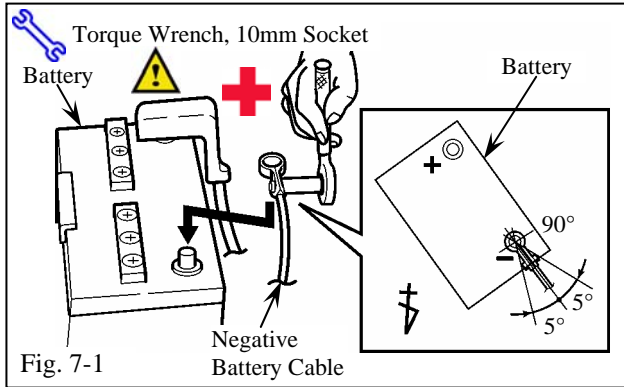

## 7. Completing the Installation.

- (a) Complete the vehicle reassembly.
  - (1) Reconnect any disconnected connectors.
  - (2) Verify the panels fit together properly with no uneven gaps between them.
- (b) Clean up and remove any trash.
- (c) Reconnect the vehicle's negative battery cable. (Fig. 7-1)
  - (1) Position the negative terminal at an angle of  $90^\circ (\pm 5^\circ)$  to the battery as shown.
  - (2) Tighten the nut to 6.35 N·m (56 lbf·in).
  - (3) Do not touch the positive terminal with any tool when replacing the cable.
- (d) Reset the power windows.
  - (1) Turn ignition key to ON position.
  - (2) Push down the power window switches of each door, and lower the windows halfway.
  - (3) Pull up the switches until the windows close and hold switches up for a further one (1) second (minimum.)
- (e) Reset the power moon roof.
  - (1) Push and hold moon roof switch to close side until moon roof closes. Hold for a further two (2) seconds.
- (f) Reset the tailgate door.
  - (1) Push door lock control switch to the "unlock" side.
  - (2) Pull up tailgate door handle.
- (g) Place the owner's manual, and warranty card, left in their protective bags, in the glove box.

Checklist - these points **MUST** be checked to ensure a quality installation.

Check:

Look For:

Accessory Function Checks

**Fit the appropriate fuse before beginning.**

Press and release the remote control's lock button to start the system's arming process.

Wait 30 seconds.

Press and release the remote control's unlock button to disarm the system.

**Open the driver's door, insert the key into the ignition switch and turn it to "ON". Roll down all the windows, remove the key and exit the vehicle.**

Arm and disarm the system with the remote again, then wait 30 seconds.

Press and release the remote control's unlock button again to stop the arming process.

Insert the key into the driver's door key cylinder and turn it toward the front of the vehicle to start the arming process.

Wait 30 seconds.

1. The tail signal lights flash once.  
All doors lock.  
The Status Monitor's LED or the Immobilizer System's LED lights up.
2. After 30 seconds, the LED starts flashing; the system is now armed.
3. The turn signal lights flash twice.  
The driver's door unlocks.  
The LED stops flashing.
4. The doors automatically relock.  
The system automatically starts the arming process.
5. Refer to step # 3.
6. All doors lock.  
The LED lights up.
7. After 30 seconds, the LED starts flashing; the system is now armed.

Checklist - these points **MUST** be checked to ensure a quality installation.

Check:

- Reach inside and manually unlock the driver's door to trigger an alarm.
  
- Manually unlock the driver's door again and hold it unlocked, open the door, then sit in the driver's seat.
  
- Insert the key into the ignition switch and turn it to "START" to stop the alarm.

**Turn the key back to "LOCK", remove it, and then exit the vehicle.**

- With the door open, press the lock switch on the door to lock the doors, then close the door to start the system's arming process.
  
- Wait 30 seconds.
  
- Reach inside and manually unlock the front passenger's door to trigger an alarm.

Look For:

- 8. The driver's door automatically relocks.  
The horn sounds repeatedly.  
The headlights flash repeatedly.  
The turn signal lights flash repeatedly.  
The LED lights up.
  
- 9. The driver's door lock attempts to lock repeatedly.  
The horn continues to sound repeatedly.  
The headlights and turn signal lights continue flashing.  
The LED remains on.
  
- 10. The horn stops sounding.  
All the lights stop flashing and/or turn off.  
The LED turns off.  
The starter cranks and the engine starts.
  
- 11. All doors lock.  
The LED lights up.
  
- 12. After 30 seconds, the LED starts flashing; the system is now armed.
  
- 13. The front passenger's door automatically relocks.  
The horn sounds repeatedly.  
The headlights flash repeatedly.  
The turn signal lights flash repeatedly.  
The LED lights up.

Checklist - these points **MUST** be checked to ensure a quality installation.

Check:

- Press and release the remote control's unlock button to stop the alarm.
- Press and release the remote control's lock button to start the system's arming process, then wait 30 seconds until the system is armed.

**Roll up all windows, remove the key and exit the vehicle.**

- Press and release the remote control's lock button to start the arming process.
- Wait 30 seconds.

**Perform the following check in a temperature-controlled environment. (50°-90° F)**



- With the tip of key (or Striker Tool pulled all the way out (PPO only)), tap the center of the driver's door window to trigger the "warn away" alarm.

- Insert the key into the driver's door key cylinder and turn it toward the back of the vehicle to stop the alarm.

Look For:

- 14. The horn stops sounding.  
All the lights stop flashing.  
The LED turns off.
- 15. Refer to step #1 and #2.
- 16. Refer to step #1.
- 17. After 30 seconds, the LED starts flashing; the system is now armed.
- 18. The horn sounds repeatedly.  
The headlights flash repeatedly.  
The turn signal lights flash repeatedly.  
The LED lights up.  
**NOTE:** Adjust as necessary by increasing the GBS setting to the next lever if the alarm does not trigger during the functional verifications.  
**NOTE:** If you do not disarm the system, the alarm will last 20 seconds. *It is not necessary to check the alarm duration.*
- 19. The horn stops sounding.  
All the lights stop flashing and/ or turn off.  
The status monitor's LED turns off.

Checklist - these points **MUST** be checked to ensure a quality installation.

Check:

Look For:

Vehicle Function Checks

- Head Lights
- High Beams
- Turn Signal Lights
- Tail Lights
- Stop Lights
- Backup Lights
- Hazard Lights
- Marker Lights
- Dome/Courtesy Lights
- Panel/Switch Illumination
- Accessory Controls/Illumination (if equipped)
- Key Sensor Buzzer
- Fog Lights (if equipped)
- Daytime Running Lights (if equipped)
- Trunk/Tailgate/Bed Lights (if equipped)
- Glove Box Light (if equipped)
- Cruise Control Light (if equipped)

- Functioning Head Lights
- Functioning High Beams
- Functioning Turn Signal Lights
- Functioning Tail Lights
- Functioning Stop Lights
- Functioning Backup Lights
- Functioning Hazard Lights
- Functioning Marker Lights
- Functioning Dome/Courtesy Lights
- Functioning Controls/Illumination
- Functioning Accessory
- Functioning Key Sensor
- Functioning Fog Lights
- Functioning DR Lights
- Functioning Lights
- Functioning Glove Box Light
- Functioning Cruise Control Light

Checklist - these points **MUST** be checked to ensure a quality installation.

Check:

- Seat Belt Warning Light
  
- Air Bag Warning Light
  
- ABS Light (if equipped)
  
- Lamp Failure Sensor (if equipped)
  
- Track/Skid Control Light (if equipped)
  
  
- HVAC
- Power Locks (if equipped)
- Power Windows (if equipped)
- Power Seats (if equipped)
- Power Sunroof (if equipped)
- Horn
- Gauges
- Front Wiper/Washer
- Rear Wiper/Washer (if equipped)
- Clock (if equipped)

Look For:

- Functioning Seatbelt Warning Light. If the warning light remains "ON", it may indicate a system malfunction.
  
- Functioning Air Bag Warning Light. If the warning light remains "ON", it may indicate a system malfunction.
  
- Functioning ABS Light. If the warning light remains "ON", it may indicate a system malfunction.
  
- Functioning Lamp Failure Light. If the warning light remains "ON", it may indicate a system malfunction.
  
- Functional Track/VSC Light. If the warning light remains "ON", it may indicate a system malfunction.
  
  
- All HVAC Controls Function
- Functioning Power Locks
- Functioning Power Windows
- Functioning Power Seats
- Functioning Sunroof
- Functioning Horn
- Functioning Gauges
- Functioning Front Wiper/Washer
- Functioning Rear Wiper/Washer
- Functioning Clock

Checklist - these points **MUST** be checked to ensure a quality installation.

Check:

- Accessory Power Socket (if equipped)
- Starter
- Audio/Video (if equipped)
- Power Sliding Door (if equipped)
- Convenience Memory Settings (if equipped)
- Heated Seats (if equipped)
- Massage Seats (if equipped)
- Rear Window Defogger (if equipped)
- Power Side Mirrors (if equipped)
- Side Mirror Defogger (if equipped)
- Front Windshield Defogger (if equipped)
- Navigation System (if equipped)

**Remove the appropriate fuse after checks are completed.**

Look For:

- Functioning Power Socket
- Functioning Starter
- Functioning Audio/Video
- Functioning Power Sliding Door
- Functioning Memory Settings
- Functioning Heated Seats
- Functioning Massage Seats
- Functioning Rear Window Defogger
- Functioning Power Side Mirrors
- Functioning Side Mirror Defogger
- Functioning Front Windshield Defogger
- Functioning Navigation System